

**General**

Provide MYSON EB34 EUROPEAN TRADITION electric towel warmer including accessories as scheduled. European Tradition towel warmers are made of 1-1/4" brass tube and fittings in a variety of finishes. The EB34 electric towel warmer is ETL approved.

Each EB34 towel warmer is constructed with integral 3-1/4" diameter wall mounting flanges that are welded onto the back. The towel warmers are equipped with a PTC smart thermo control element certified ISO 9001 and a back lit on/off rocker switch. Each unit is filled to a precise level with a glycol based heat transfer fluid for optimum convective flow, providing a constant surface temperature. Every unit is factory tested to insure the finest quality product with design temperature output.

**Standard Connection:**  
single gang box

**Electrical Specifications:**  
120 Vac 60 Hz 100 Watts

**Weight:**  
40 lbs.

**Available Finishes:**

Polished Chrome, Polished Nickel, Satin Nickel, Regal Brass, Oil-Rubbed Bronze, White

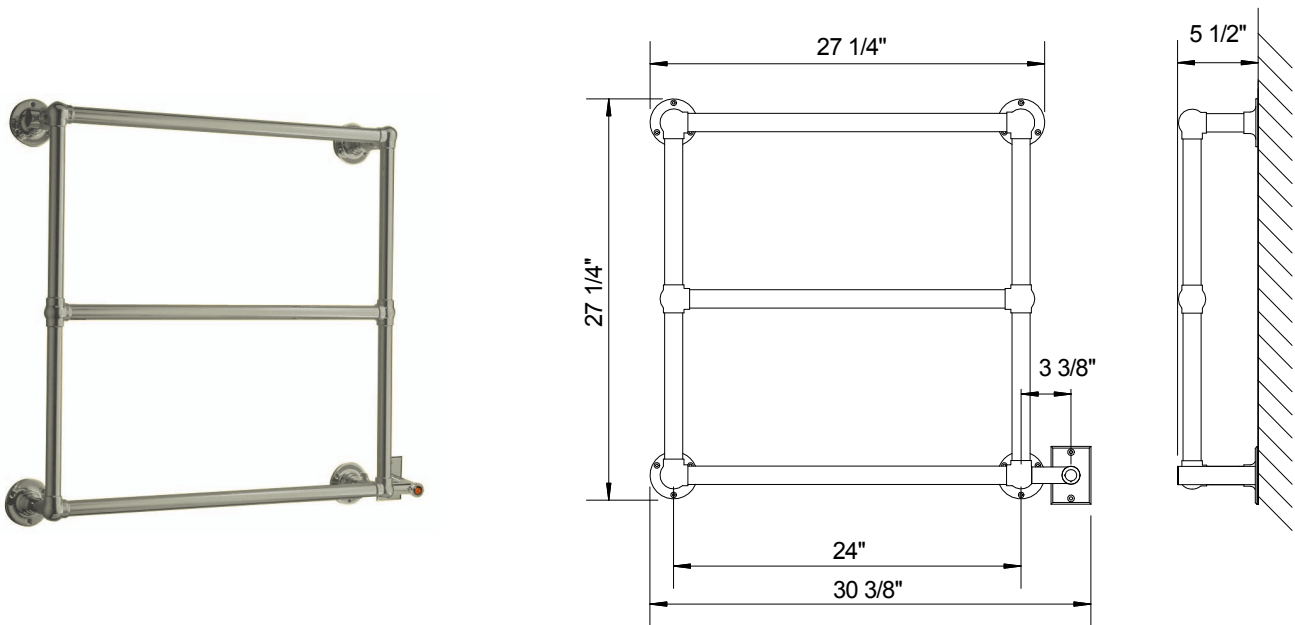

**Warranty:**  
MYSON European Tradition Towel Warmers are covered by a 10 year warranty.

An optional **ST01C** programmable timer is recommended and available from **MYSON**.



**Quality certificates**



PROJECT NAME:  
ARCHITECT:  
ENGINEER:  
SUBMITTED DATE:

APPROVED DATE:

APPROVED